

fra

fre

fri

fro

fru

Nombre: .....

Curso: .....

Rodea el sonido que tenga el dibujo:

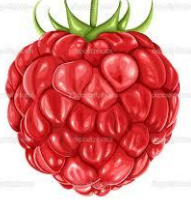
	fra
	tra
	cra
	far

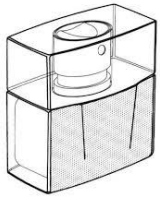
	far
	bre
	gra
	fra

	cer
	fer
	fre
	ser

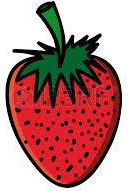
	ber
	fre
	gre
	cre

	fre
	bre
	be
	pre

	bri
	fri
	pri
	fir

	bri
	bi
	fri
	fir

	gri
	fri
	fir
	firi

Rodea el sonido que tenga el dibujo:

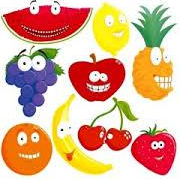
	fro
	fru
	fur
	sur

	fro
	for
	cro
	gro

Rodea el dibujo que tenga el sonido fra

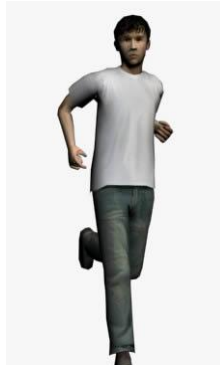
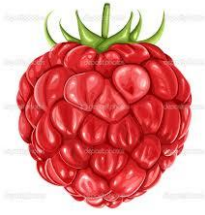

SARA



Rodea los dibujos que tengan el sonido fre

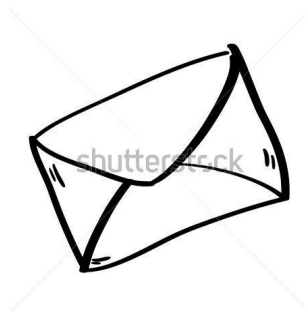
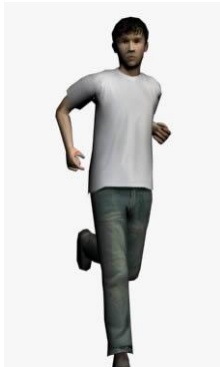

Rodea los dibujos que tengan el sonido fri

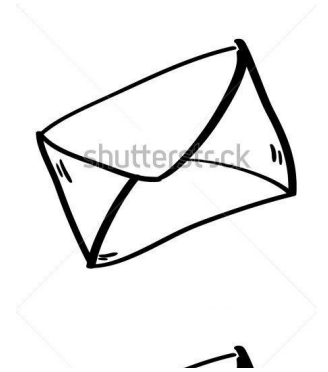

SARA



Rodea los dibujos que tengan el sonido fro

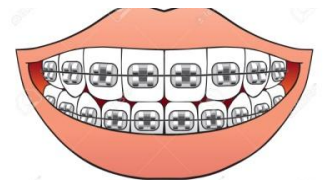
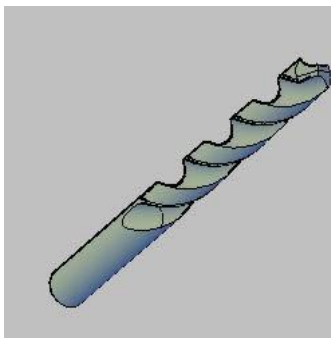
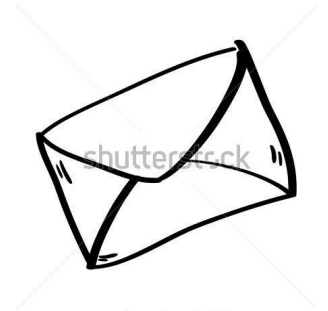
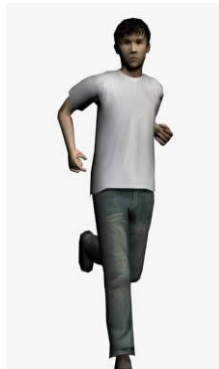

Rodea los dibujos que tengan el sonido fru

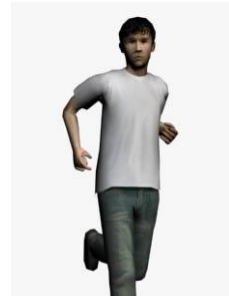
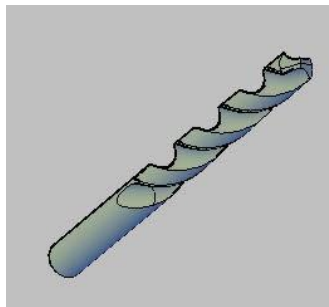
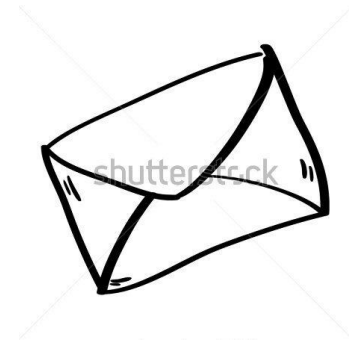
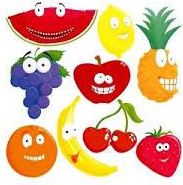

Rodea la sílaba fra

fra      fre      fri      fra      fro      fra  
fri      fra      fra      fra      fra      fru  
fru      fru      fra      fre      fro      fra

Rodea la sílaba fre

fra      fre      fri      fra      fro      fra  
fri      fra      fra      fra      fra      fru  
fru      fru      fra      fre      fro      fra

Rodea la sílaba fri

fra      fre      fri      fra      fro      fra  
fri      fra      fra      fra      fra      fru  
fru      fru      fra      fre      fro      fra

Rodea la sílaba fro

fra      fre      fri      fra      fro      fra  
fri      fra      fra      fra      fra      fru  
fru      fru      fra      fre      fro      fra

Rodea la sílaba fru

fra      fre      fri      fra      fro      fra  
fri      fra      fra      fra      fra      fru  
fru      fru      fra      fre      fro      fra

Completa estas palabras con la sílaba correspondiente:

	¿fro?	.....tar
	¿for?	

	¿fru?	.....tería
	¿fur?	

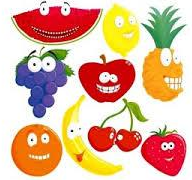
	¿fur?	.....ta
	¿fru?	

	¿fri?	.....o
	¿fir?	





Completa estas palabras con la sílaba correspondiente:

	¿fri?	res.....ado
	¿fir?	

	¿fri?	.....gorífico
	¿fir?	

	¿fer?	re.....sco
	¿fre?	

	¿fra?	.....mbuesa
	¿far?	

	¿fre?	.....gona
	¿fer?	

Completa estas palabras con la sílaba correspondiente:

	¿fra?	re.....n
	¿far?	

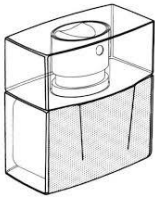
	¿fra?	.....sco
	¿far?	

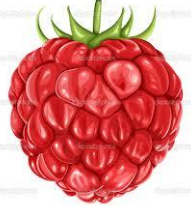
	¿fra?	.....mbuesa
	¿far?	

Copia y relaciona cada palabra con su imagen:

frambuesa

.....



fregona

.....

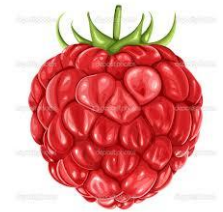

resfriado

.....



frutas

.....



frutería

.....



Copia y relaciona cada palabra con su imagen:

frío

.....



refrán

.....





refresco

.....





Rodea las sílabas y escribe debajo la palabra:

	lu	fres	bru
	bri	fer	po
	re	ber	lo
	lo	bar	co
	bur	bor	bre

	fram	bu	e	sa
	fa	gu	e	so
	far	ram	e	se
	fre	tu	e	te
	for	ñu	e	le

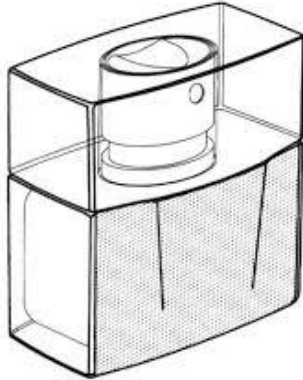
Rodea las sílabas y escribe debajo la palabra:

	fras	lo
	far	co
	fer	zo
	fre	cho
	fara	jo

	re	frun
	ro	fron
	ri	fren
	ru	far
	de	fran

Rodea las sílabas y escribe debajo la palabra:

	fer	go	la
	fre	jo	na
	fere	cho	an
	fri	llo	ma
	gre	gro	am

	fer	sa
	fre	as
	fe	zas
	fi	cas
	fu	jas

Rodea las sílabas y escribe debajo la palabra:

	for	ter
	fro	tar
	fre	taf
	fri	tag
	fru	tac

	fur	tas
	fru	tos
	fu	taz
	fe	tal
	fre	tan



Rodea las sílabas y escribe debajo la palabra:

	res	fir	a	de
	ris	fri	o	do
	ros	fi	e	du
	ras	fre	i	di
	rus	fru	u	da

	fre	a
	fri	o
	fro	e
	fir	u
	fer	i

Rodea las sílabas y escribe debajo la palabra:

	fir	go	ri	fa	zo
	fri	fo	re	fe	co
	fi	que	ru	fi	jo
	fe	qui	ra	fo	so
	fu	jo	ro	fu	go

	fra	ta	ra	a
	fre	te	re	e
	fri	ti	ri	i
	fro	to	ro	o
	fru	tu	ru	u

Ordena las letras para formar la palabra:



f r  
o t  
a r

.....



f r t  
u e  
a r i

.....



f r f  
i g i  
o r i c o

.....



r e f  
s i r  
d a o

.....



r f o  
i

.....

Ordena las letras para formar la palabra:



r e f  
r e s  
o c

.....



f r  
e s a

.....



r e f  
g o  
a n

.....



r e f  
a r n

.....

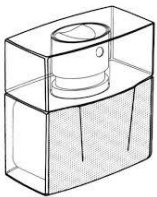

f r  
a s  
c o

.....

Escribe la palabra correspondiente al dibujo:

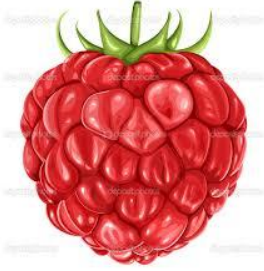

.....

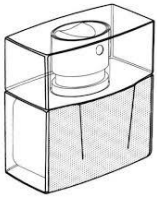

.....



.....



.....

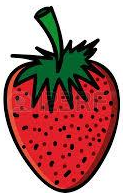

.....

Escribe la palabra correspondiente al dibujo:



.....



.....



.....



.....



.....

Elige la palabra correcta:



¿frutas o furtas?

.....

¿furtería o frutería?



.....

¿refresco o refresco?



.....

¿resfiro o resfriado?



.....

¿firio o frio?



.....

Elige la palabra correcta:



¿refan o refrán?

.....



¿frigorífico o firgorífico?

.....

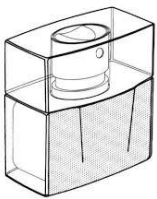

¿fasco o frasco?

.....



¿frotar o fortar?

.....



¿fersa o fresa?

.....



Completa las oraciones con la palabra que corresponde al dibujo:



Ayer comí ..... con nata .



En la ducha me .....con la esponja.

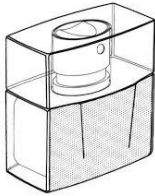

El .....de la colonia está roto.



Mi .....está lleno de comida.



En la pared hay un .....

Completa las oraciones con la palabra que corresponde al dibujo:



Este chico tiene .....



Con este frío me he .....



Me encanta el ..... de cocacola.



En la ..... venden muchas  
verduras y frutas.



Me gustan mucho las .....

Escribe una oración con la palabra que corresponde al dibujo:



.....

.....



.....

.....



.....

.....

Escribe una oración con la palabra que corresponde al dibujo:



.....

.....



.....

.....

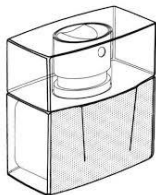

.....

.....

Escribe una oración con la palabra que corresponde al dibujo:



.....



Escribe una oración con la palabra que corresponde al dibujo:



---

---



---

---



---

---