

cha

che

chi

cho

chu

Nombre: .....

Curso:.....

Rodea el sonido que tenga el dibujo:

	cha
	ca
	ja
	che

	cha
	ja
	lla
	ja

	cha
	ca
	lla
	da

	cho
	zo
	co
	llo

	cho
	co
	jo
	xo

	che
	chu
	cha
	chi

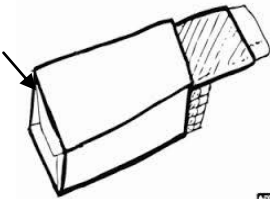
	chi
	che
	cha
	chu

	chi
	lli
	cho
	cha

Rodea el sonido que tenga el dibujo:

	chi
	cha
	che
	cho

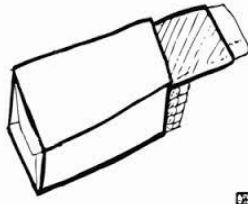
	chi
	che
	cha
	chu

	cho
	chi
	che
	fo

	chi
	cho
	chu
	cu

	cho
	zo
	che
	cha

	che
	cha
	cho
	chu

	cha
	che
	chi
	za

	cha
	za
	lla
	ña

Rodea el dibujo que tenga el sonido chu

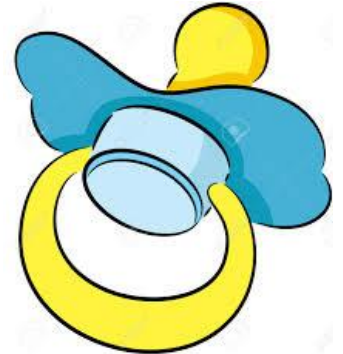

Rodea los dibujos que tengan el sonido chi

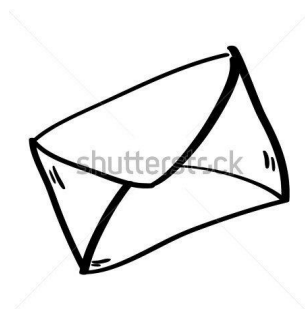

Rodea los dibujos que tengan el sonido cha

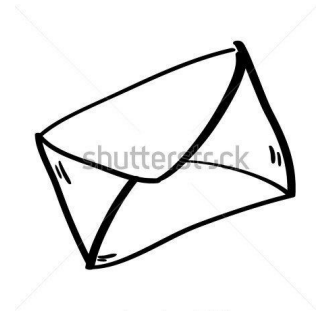

Rodea los dibujos que tengan el sonido cho

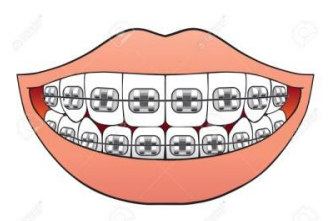
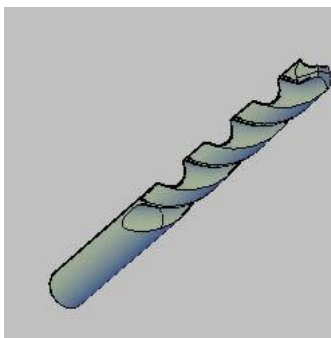

Rodea los dibujos que tengan el sonido che

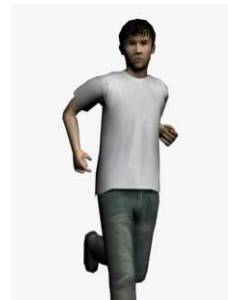
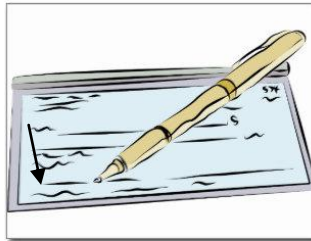
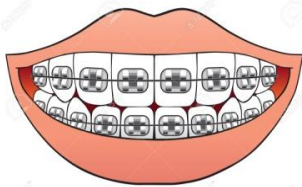
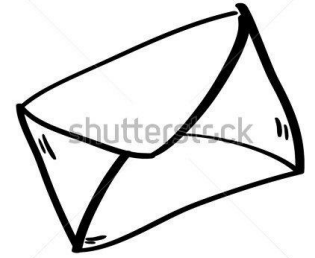

Rodea la sílaba chi

cha	che	chi	cho	chu	cha
chi	cha	chi	cha	cha	chi
cha	che	chi	cho	chu	cha

Rodea la sílaba chu

cha	che	chi	cho	chu	cha
chi	cha	chi	cha	cha	chi
cha	che	chi	cho	chu	cha

Rodea la sílaba cha

cha	che	chi	cho	chu	cha
chi	cha	chi	cha	cha	chi
cha	che	chi	cho	chu	cha

Rodea la sílaba che

cha	che	chi	cho	chu	cha
chi	cha	chi	cha	cha	chi
cha	che	chi	cho	chu	cha

Rodea la sílaba cho

cha	che	chi	cho	chu	cha
chi	cha	chi	cha	cha	chi
cha	che	chi	cho	chu	cha

Completa estas palabras con la sílaba correspondiente:

	¿cha?	.....pa
	¿ca?	

	¿cha?	.....queta
	¿cho?	

	¿cha?	.....nclas
	¿ja?	

	¿cho?	.....rizo
	¿fo?	



Completa estas palabras con la sílaba correspondiente:

	¿cho?	.....colate
	¿go?	

	¿cho?	.....fer
	¿fo?	

	¿chi?	cu.....llo
	¿ci?	

	¿chi?	.....menea
	¿si?	

Completa estas palabras con la sílaba correspondiente:

	¿che?	.....f
	¿fe?	

	¿be?	.....que
	¿che?	

	¿chu?	.....rros
	¿zu?	

	¿chu?	.....pete
	¿llu?	

Copia y relaciona cada palabra con su imagen:

cheque

.....



chef

.....



churros

.....



chupete

.....

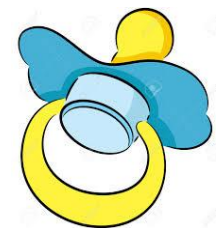

chorizo

.....



Copia y relaciona cada palabra con su imagen:

chocolate

.....



chicle

.....



cuchillo

.....

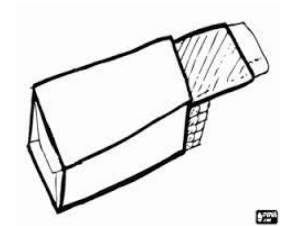

chanclas

.....





chimenea

.....





Rodea las sílabas y escribe debajo la palabra:

	chu	rros
	cho	rras
	cha	rres
	che	rris

	cu	chu	lla
	ca	cho	llo
	za	cha	lle
	zu	che	jo
	chu	chi	co

Rodea las sílabas y escribe debajo la palabra:

	cha	que	ta
	che	ce	sa
	ña	gue	tra
	lla	pe	la

	cho	fer
	ño	fre
	fo	der
	yo	fe

Rodea las sílabas y escribe debajo la palabra:

	sal	chi	chas
	as	cha	ñas
	zal	chu	fas
	cal	che	ches

	cha	pa
	che	pe
	chi	pi
	cho	po

	chi	ca	la	te
	che	co	le	ta
	cho	cu	lo	tu
	chu	que	li	to

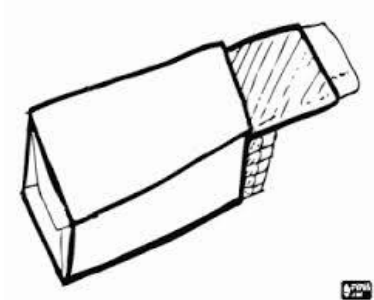
	chi	clets	
	ñi	celt	
	wi	quets	
	zi	crets	





chi	ma	na	a
chu	me	ne	o
cha	mu	nu	e
che	mi	ni	u

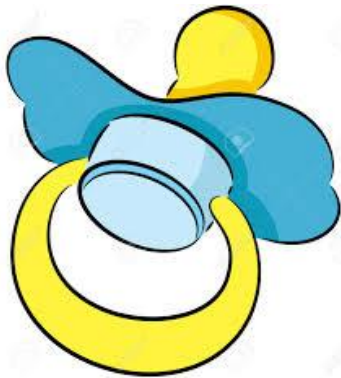

cha	pa	te
chu	pu	ta
che	pe	ti
chi	pi	to
cho	po	tu



cha

que

che

ca

chi

qui

cho

co

Ordena las letras para formar la palabra:

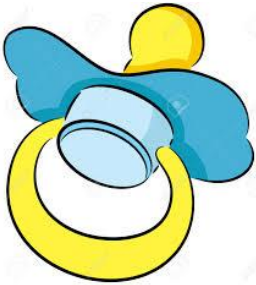

c u h  
p t e  
e

.....

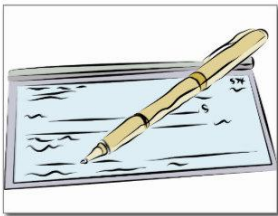

c h q e  
u e

.....



c h m i e  
n a e

.....



c h c  
o o l  
a e t

.....

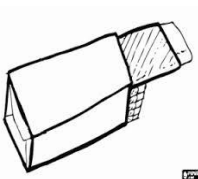

c h i  
l c e t  
s

.....

Ordena las letras para formar la palabra:



c u  
c i h i o  
l l o

.....



c h f  
o e r

.....



c h a  
u e q  
a t

.....



c h a  
n c l  
a s

.....



c a h  
p a

.....

Escribe la palabra correspondiente al dibujo:



.....

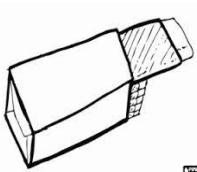

.....



.....



.....



.....

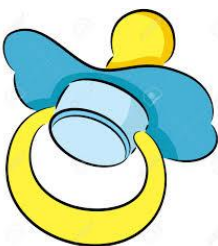

Escribe la palabra correspondiente al dibujo:



.....



.....



.....



.....

Elige la palabra correcta:

¿chapa o gapa?



.....

¿cheque o jeque?



.....

¿chocolate o pocholate?



.....

¿chiclets o siclets?

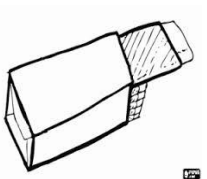

.....

Elige la palabra correcta:



¿salchichas o salxillas?

.....



¿chimenea o chemenea?

.....



¿chocolate o ñocolate?

.....



¿chanclas o yanclas?

.....

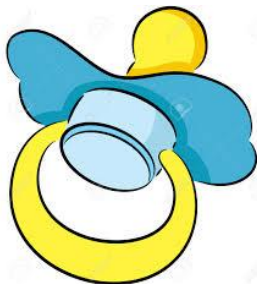

¿chupete o fupete?

.....



Completa las oraciones con la palabra que corresponde al dibujo:

Colecciono  .....

de colores.

Mi  .....

es lila, rosa y verde.

Uso las  .....

para ir a la playa

Esta noche cenaré  .....

El  .....

es un postre

que me encanta.

Completa las oraciones con la palabra que corresponde al dibujo:

El bebé necesita el  .....

La  ..... está encendida

Me gustan mucho los  .....

El  .....del autobús se llama Juan.

Mis padres han firmado el  .....

Escribe una oración con la palabra que corresponde al dibujo:



.....  
.....



.....  
.....



.....  
.....



.....  
.....

CHA, CHE, CHI, CHO, CHU

Marta Parra Lubary  
Ester Rebollo Ferrer  
Margalida Tortella Mateu



.....

.....



.....

.....

Escribe una oración con la palabra que corresponde al dibujo:



.....

.....

.....

.....



.....

.....

.....

.....



.....

.....

.....

.....

Escribe una oración con la palabra que corresponde al dibujo:



.....

.....

.....

.....



.....

.....

.....

.....



.....

.....

.....

.....