

Nombre:

Fecha:

NÚMEROS HASTA EL 100

77	
28	
	64
41	
23	
	70
	65

Completa
la casita
de
descomposición

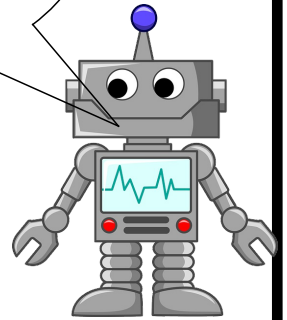

Completa los
números de la
recta.

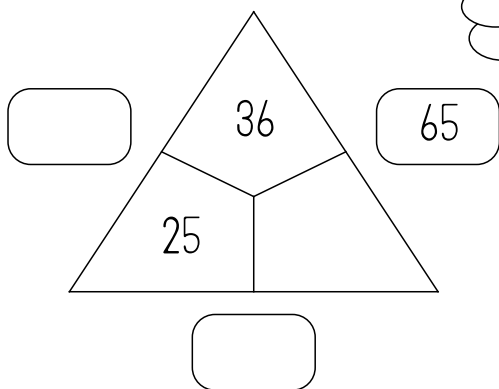
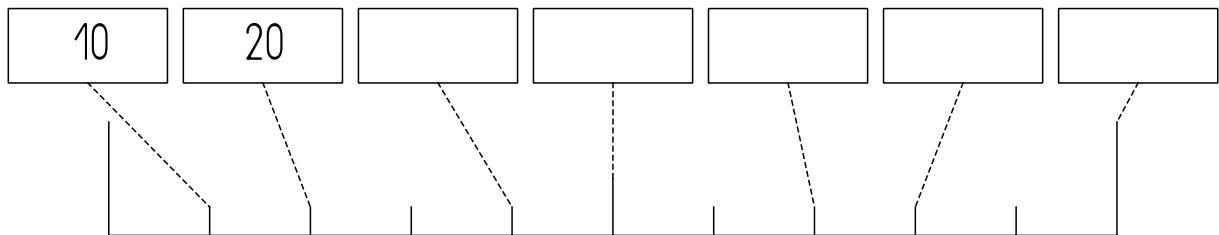
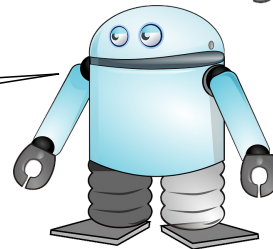

¿Podrás
hacerlo?

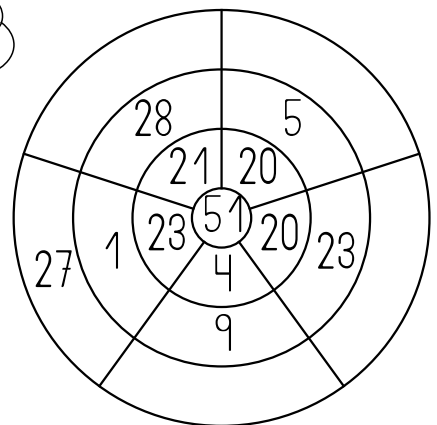
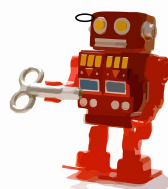

He empezado:

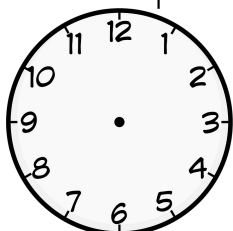

He acabado:

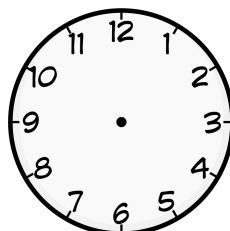

He tardado:

Nombre:

Fecha:

NÚMEROS HASTA EL 200

173	
	2
35	
11	
31	
	59
	26

Completa
la casita
de
descomposición

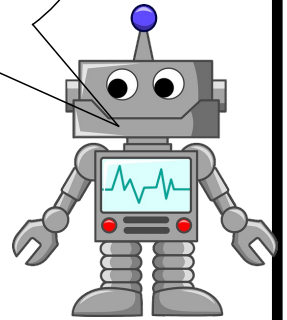

Completa los
números de la
recta.

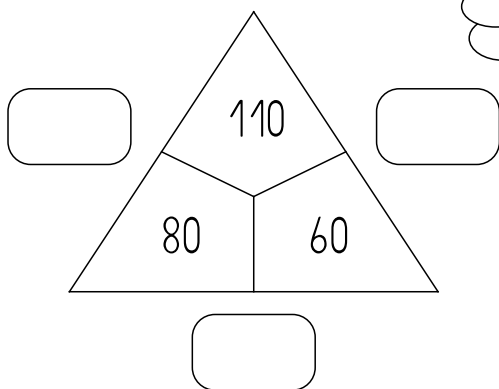
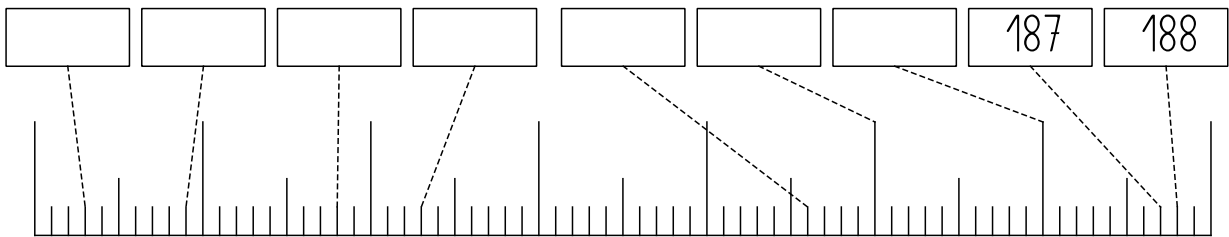
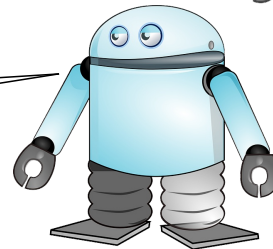

¿Podrás
hacerlo?

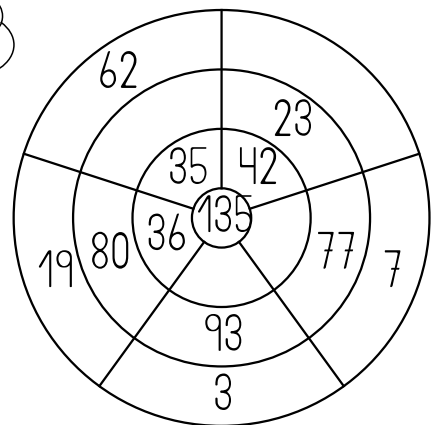
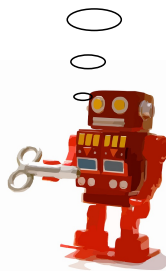

He empezado:

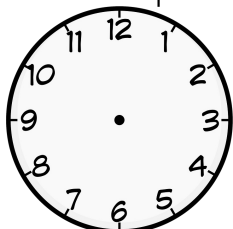

He acabado:

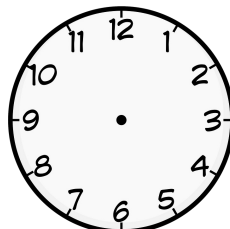

He tardado:

Nombre:

Fecha:

NÚMEROS HASTA EL 300

241	
	1
127	
	50
213	
	190
	150

Completa
la casita
de
descomposición

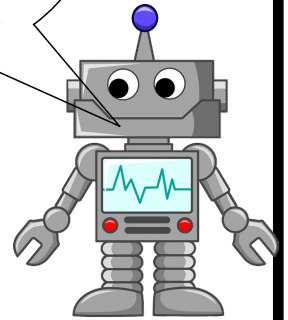

Completa los
números de la
recta.

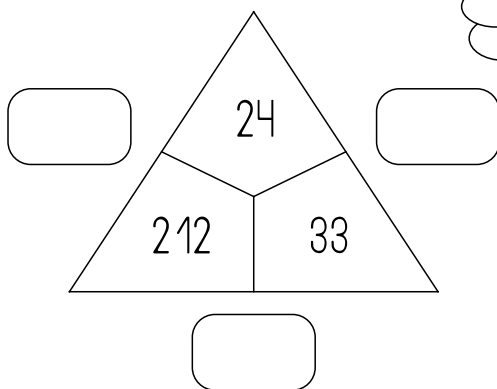
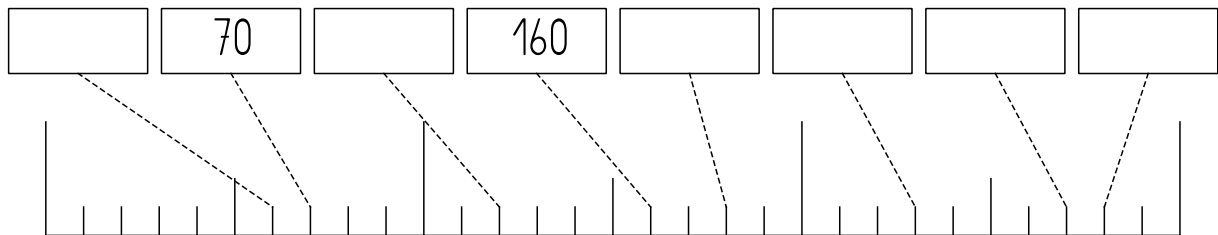
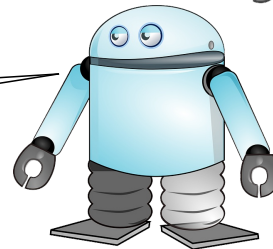

¿Podrás
hacerlo?

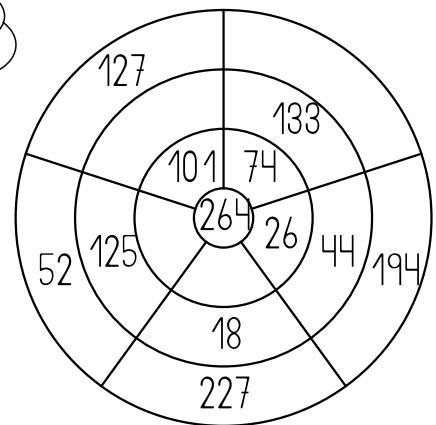
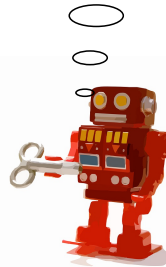

He empezado:

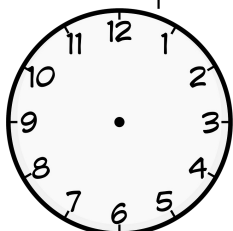

He acabado:

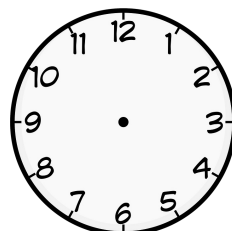

He tardado:

Nombre:

Fecha:

NÚMEROS HASTA EL 400

180	
2	
	40
	152
4	
168	

Completa la casita de descomposición

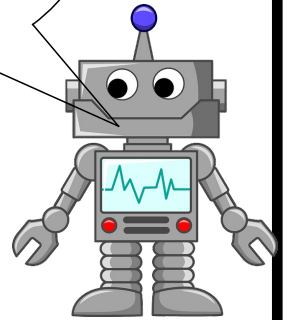

Completa los números de la recta.

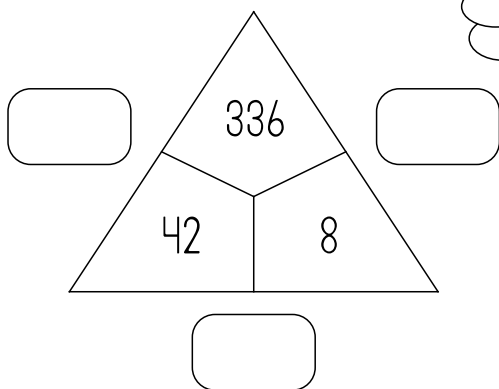
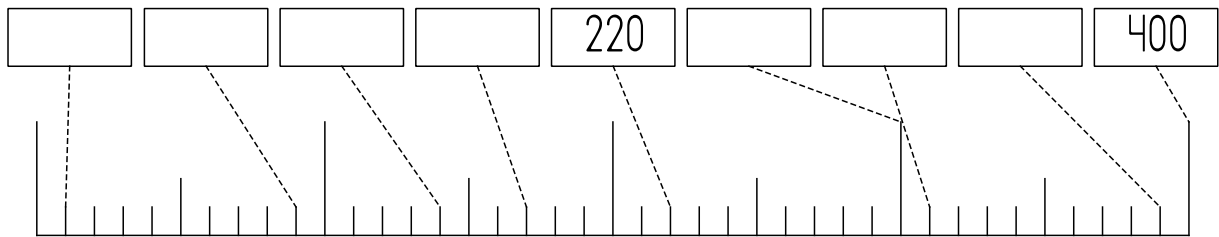
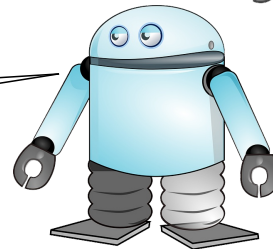

¿Podrás hacerlo?

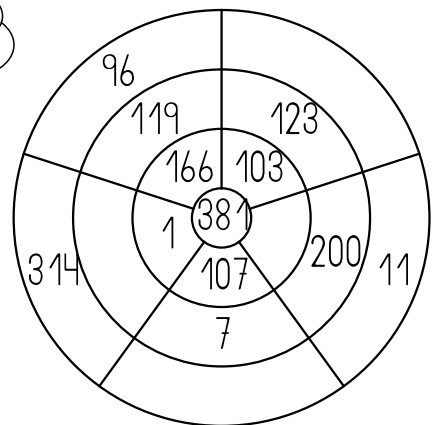
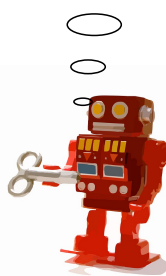

He empezado:

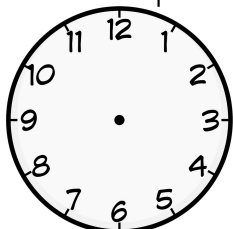

He acabado:

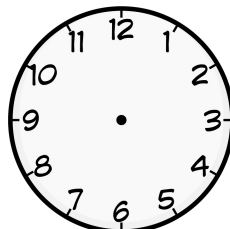

He tardado:

Nombre:

Fecha:

NÚMEROS HASTA EL 500

471	
421	
	448
	93
296	
455	

Completa
la casita
de
descomposición

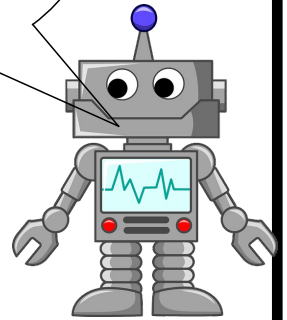

Completa los
números de la
recta.

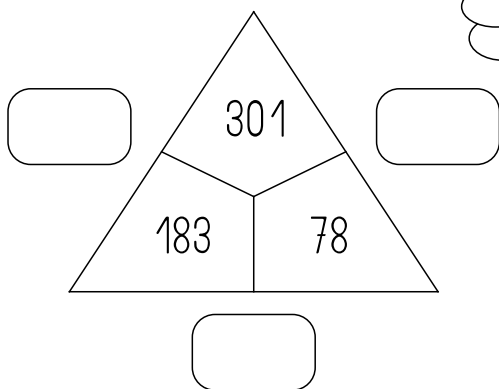
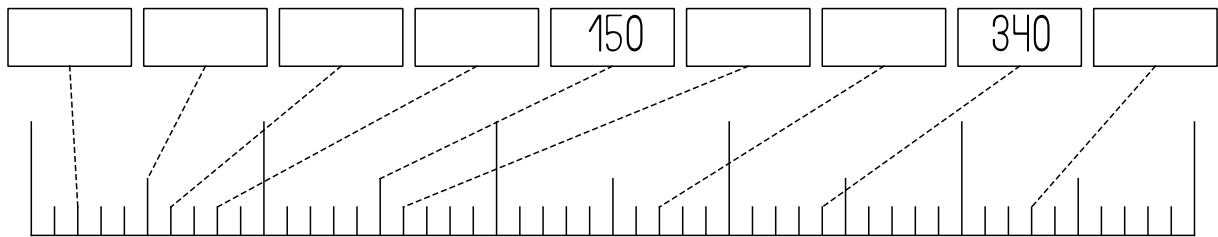
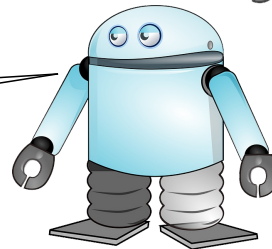

¿Podrás
hacerlo?

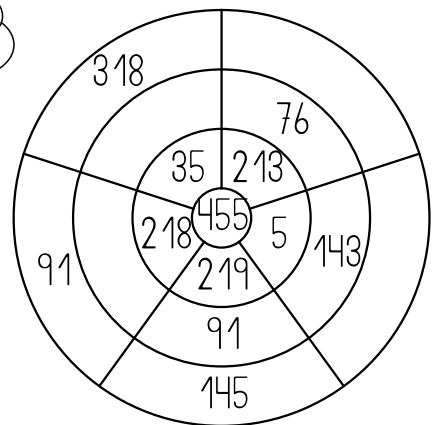
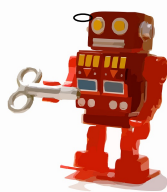

He empezado:

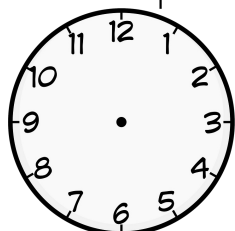

He acabado:

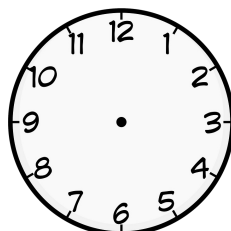

He tardado:

Nombre:

Fecha:

NÚMEROS HASTA EL 600

571	
	370
133	
	534
	459
	126

Completa
la casita
de
descomposición

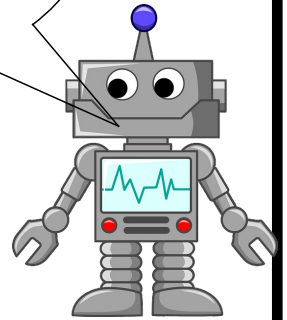

Completa los
números de la
recta.

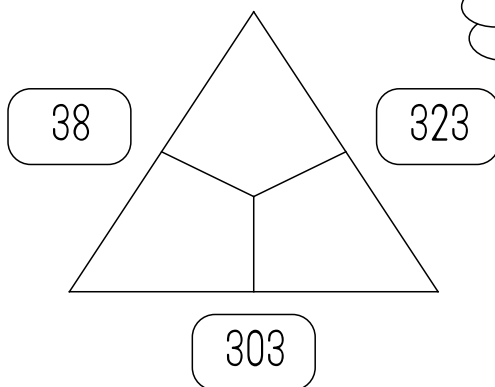
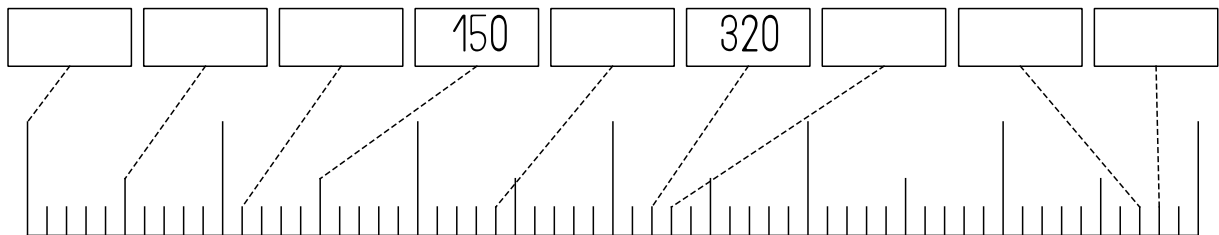
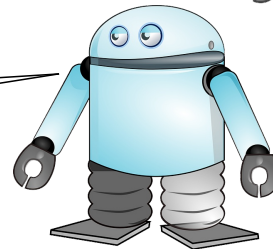

¿Podrás
hacerlo?

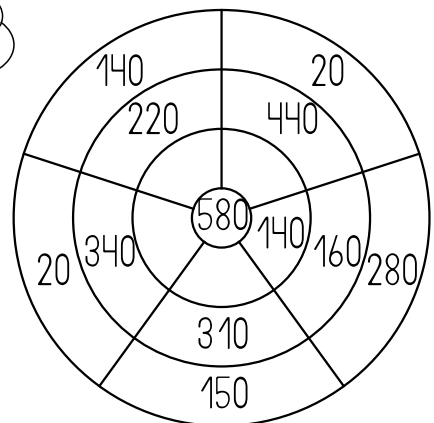
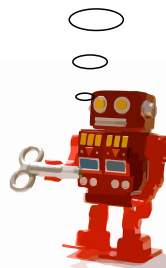

He empezado:

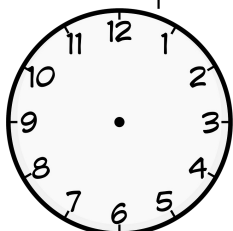

He acabado:

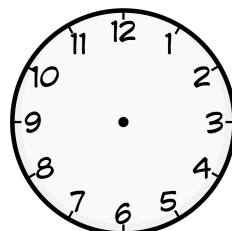

He tardado:

Nombre:

Fecha:

NÚMEROS HASTA EL 700

629	
	325
222	
23	
	248
190	

Completa
la casita
de
descomposición

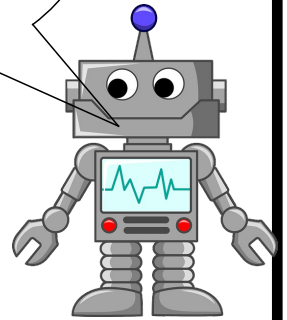

Completa los
números de la
recta.

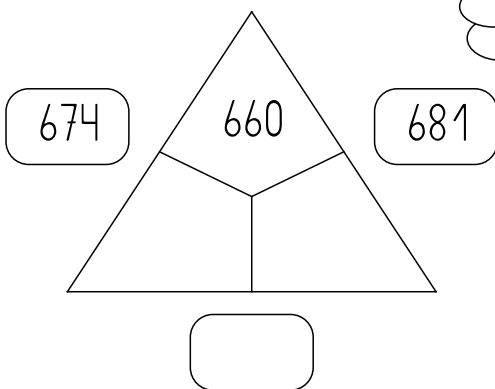
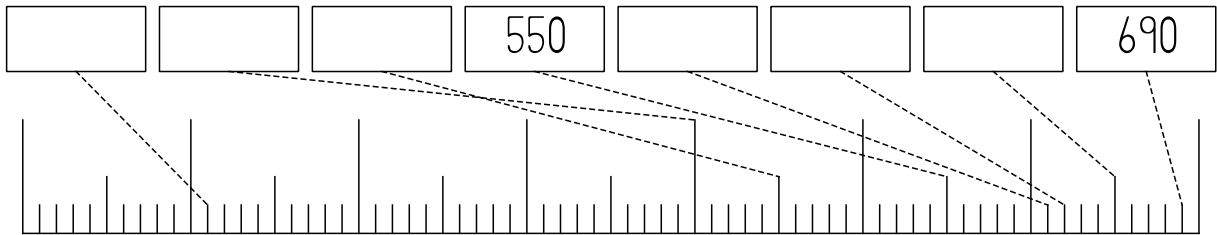
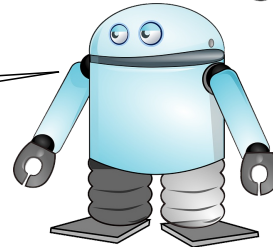

¿Podrás
hacerlo?

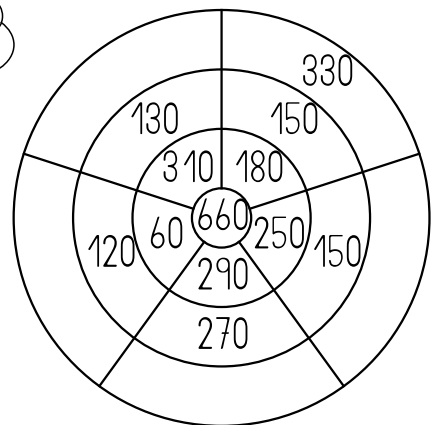
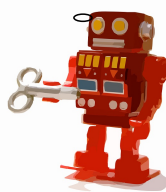

He empezado:

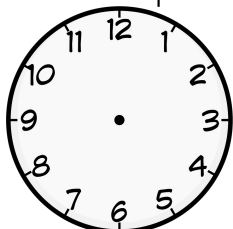

He acabado:

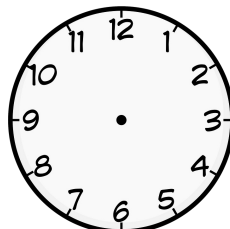

He tardado:

Nombre:

Fecha:

NÚMEROS HASTA EL 800

796	
24	
	8
530	
	236
	48

Completa
la casita
de
descomposición

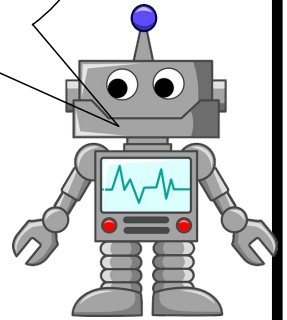

Completa los
números de la
recta.

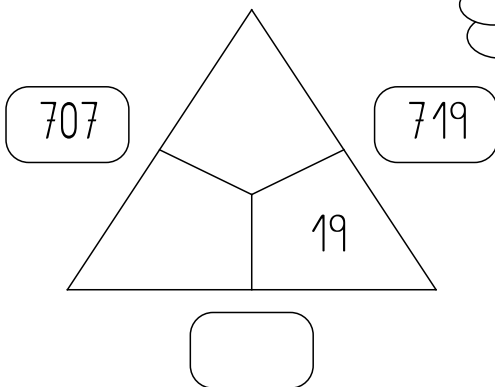
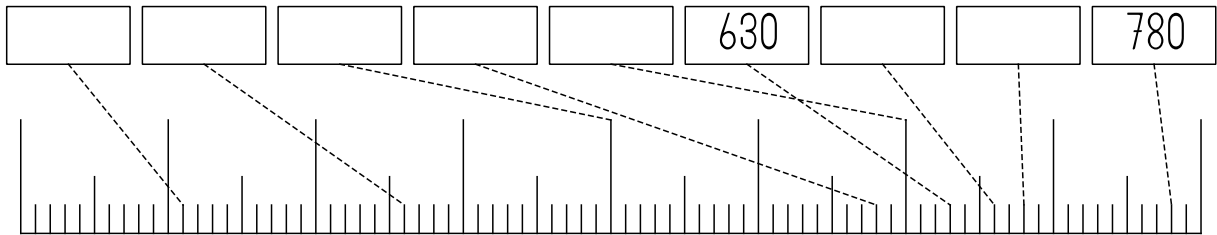
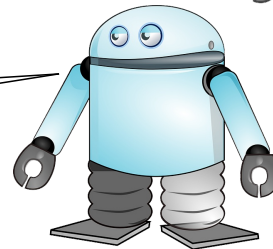

¿Podrás
hacerlo?

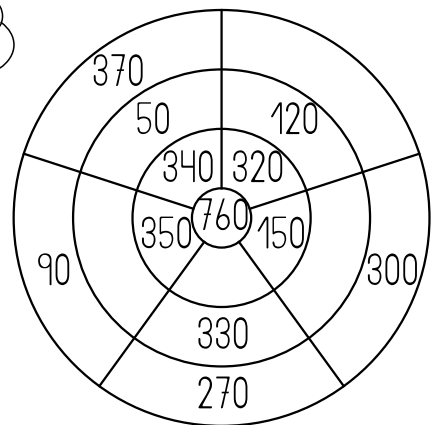
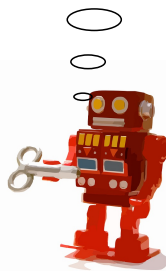

He empezado:

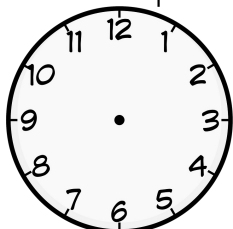

He acabado:

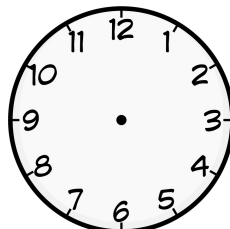

He tardado:

Nombre:

Fecha:

NÚMEROS HASTA EL 900

890	
752	
	156
96	
717	
	541

Completa
la casita
de
descomposición

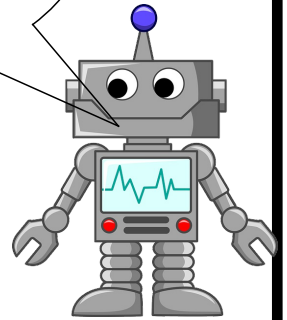

Completa los
números de la
recta.

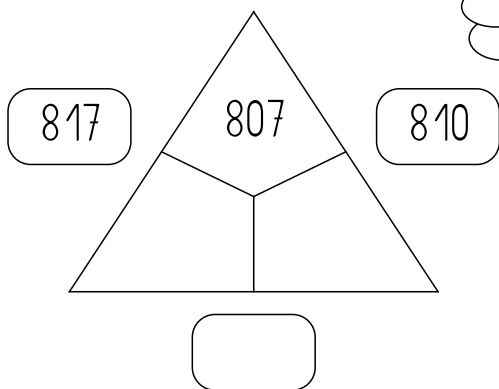
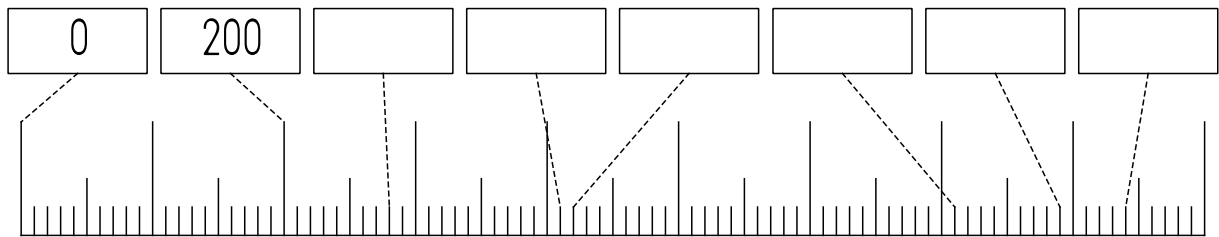
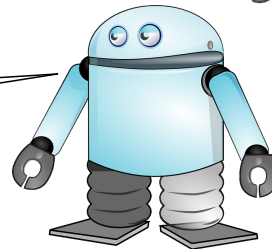

¿Podrás
hacerlo?

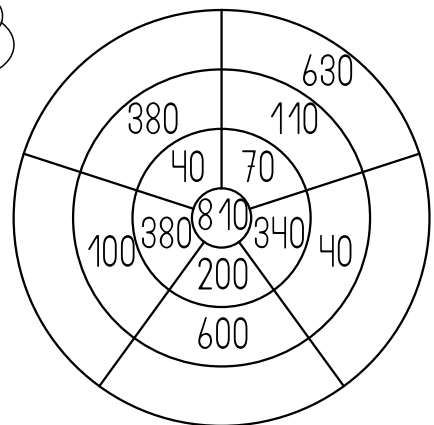
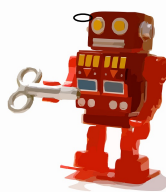

He empezado:

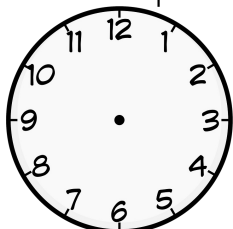

He acabado:

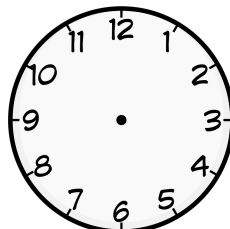

He tardado:

Nombre:

Fecha:

NÚMEROS HASTA EL 1000

960	
670	
800	
	560
110	
160	

Completa
la casita
de
descomposición

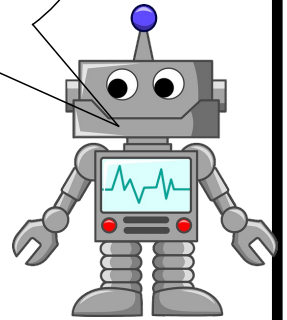

Completa los
números de la
recta.

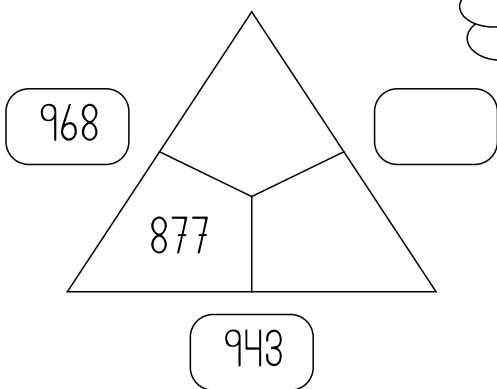
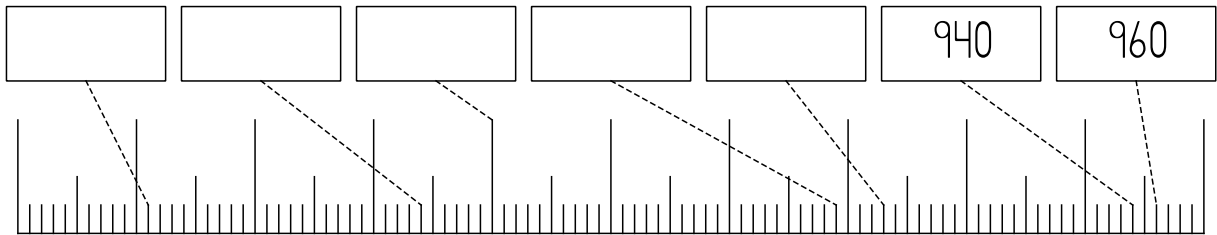
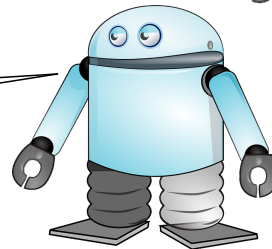

¿Podrás
hacerlo?

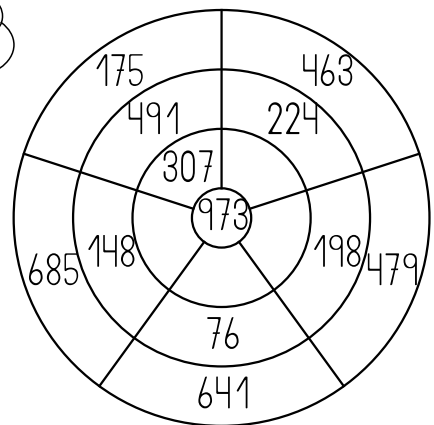
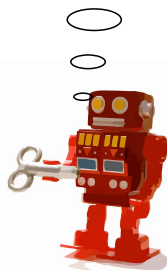

He empezado:

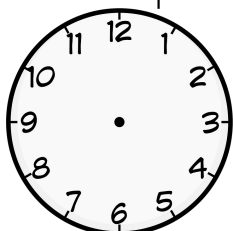

He acabado:

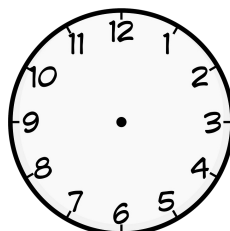

He tardado: